

MOUNTING HARDWARE

Versatile mounting hardware

Frame type

Identify chair's frame type and then select compatible mounting hardware for belts and harnesses.

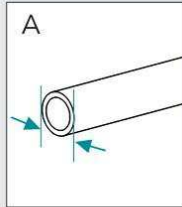

Round

Ø19, 22, 25, 29, 30, 32mm tubing

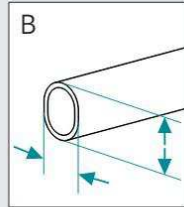

Oval

Quickie Wheelchairs
27mm x 33mm

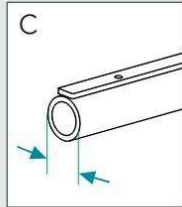

Tube

With threaded holes for seat upholstery strip

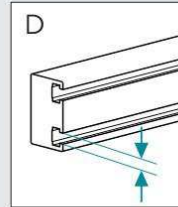

6mm T-Slots

Permobil Unitrack

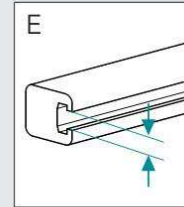

10mm T-Slots

Invacare, Pride and Quantum slotted rails



90° Seat Mounting Bracket

Frame type: C
HW200-90-2

Mounting solution for chairs with sling seat upholstery or a solid seat base. 90° bend for top mounting on seat tubes (pictured at right), or a 20° bend for side mounting. Sold in pairs.



20° Seat Mounting Bracket

Frame type: C
HW200-20-2



6mm T-Slot Fastener Kit

Frame type: D
HKA6-1



10mm T-Slot Fastener Kit

Frame type: E
HKA10-1

Directly mount belts or harnesses to power wheelchair slotted rails. 6mm size for Permobil chairs, or 10mm size for Invacare and Pride/Quantum chairs.

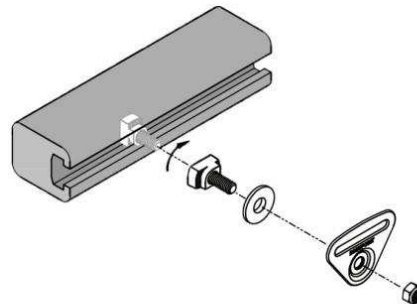

MOUNTING HARDWARE



Band Clamp

Frame types: A, B, C

Flexible stainless spring steel fits into tight gaps under seats on a wide variety of frames. Useful for mounting where there are no pre-existing holes. Sold in pairs.

- HW320-22-2 Ø22mm (7/8")
- HW320-25-2 Ø25mm (1")
- HW320-27X33-2 27 x 33mm (1-1/16" x 1-5/16"), oval
- HW320-29-2 Ø29mm (1-1/8")
- HW320-30-2 Ø30mm (1-3/16")
- HW320-32-2 Ø32mm (1-1/4")



FrameSaver™ Clamp & Shim

Frame type: A

Strong, durable nylon clamps snap onto tubing and won't scratch surface. Our most affordable clamp, the FrameSaver is perfect when clearance is not an issue. Fits Ø25mm (1") tubing, and 22mm (7/8") tubing with enclosed shim. Can also be used on Ø19mm (3/4") tubing with 19mm shim, sold separately. Sold in pairs.

- HW303-B-2 25mm clamp + 22mm shim
- HW303-19SHIM-2 19mm shim



Hardware Gauge

This indispensable tool for measuring tubing diameter helps you choose the correct mounting hardware. It's also an easy way to select correctly-sized screws and nuts for a particular wheelchair.

BMR-42



Frame Clamp

Frame types: A, C

Open-jaw design fits underneath seat upholstery and armrest pads. Made with sturdy, two-piece aluminum construction. Sold in pairs.

- HW310-22-A-2 For Ø22mm (7/8") tubes
- HW310-25-A-2 For Ø25mm (1") tubes

NEW! Evoflex® Belt Extender

Made of high-impact plastic, the Evoflex® Belt Extender maintains the stiffness of the Evoflex while lengthening the belt up to 12.5 cm (5"). Perfect for mounting to wheelchairs with thicker cushions, deeply contoured seating, or distant mounting points. Available separately or bundled with the Evoflex belt. See page 10 for more information.



EBE100

Cam Buckles



Convenient end-fitting option for evaluation setting or whenever temporary fittings are needed. Also suitable for long-term use with chest or shoulder harnesses on users up to 75kg. Mount to solid backrest or Strap Guides. Ø6mm (1/4") hole. Sold in pairs.

- FS032-2 Fits 2.5cm (1") wide webbing belts & harnesses
- FS033-2 Fits 4cm (1-1/2") wide webbing belts
- FS034-2 Fits 5cm (2") wide webbing belts

Shoulder Harness Strap Guides

Improve positioning and comfort of chest and shoulder harnesses by optimizing height and angle of top straps. See page 8 for more information.



Strap Guides

- HW100-200-2 Long 200mm (8")
- HW100-150-2 Short 150mm (6")



Mounting Adapters (optional)

- HW105L-1 Large 270 x 75mm (10-5/8" x 3")
- HW105S-1 Small 185 x 75mm (7-1/4" x 3")

SIZING

How to Measure for a Padded Hip Belt

To ensure proper fit and best performance, always select the padded belt size that best fits the user. When working with the Evoflex, consider adding Belt Extenders if longer straps are needed to reach the desired mounting point (see right).

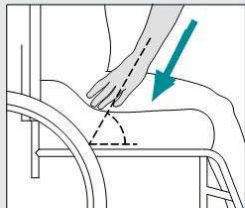

Determine the correct belt size for the user:

1. Based on clinical goals, use arms to place user in desired position and determine the most effective position and angle for the belt.
2. At the selected belt angle, measure the distance over the body with a flexible tape to find the optimal length for the belt's padded section.
3. In the sizing table for your belt style, refer to Column B to find the appropriate belt size based on padded length. If user is between sizes, consider factors such as growth, weight variations and clothing changes. For proper fit and function, pads should not extend past the user's body.

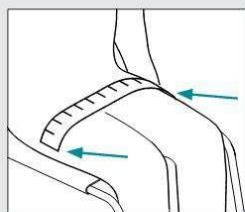

Two-Point and Four-Point Padded Hip Belts

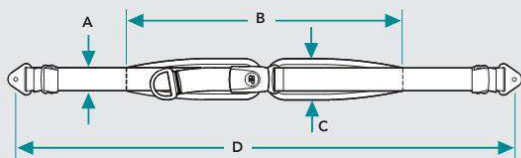

| Size* | A | B | C | D |
|-------|--------------|----------------|----------------|-------------|
| S32 | 2.5cm (1") | 32cm (12-1/2") | 4.5cm (1-3/4") | 117cm (46") |
| S38 | 2.5cm (1") | 38cm (15") | 5cm (2") | 117cm (46") |
| M36 | 4cm (1-1/2") | 36cm (14") | 5.5cm (2-1/4") | 130cm (51") |
| M40 | 4cm (1-1/2") | 40cm (15-3/4") | 5.5cm (2-1/4") | 142cm (56") |
| M46 | 4cm (1-1/2") | 46cm (18") | 5.5cm (2-1/4") | 142cm (56") |
| L62 | 5cm (2") | 62cm (24-1/2") | 7cm (2-3/4") | 155cm (61") |
| L82 | 5cm (2") | 82cm (32") | 9cm (3-1/2") | 206cm (81") |
| L92 | 5cm (2") | 92cm (36") | 10cm (4") | 206cm (81") |

Leg Harnesses

Measure from the anterior superior iliac spine (ASIS) to the point where the inner thigh touches the seat.

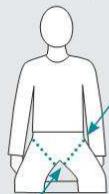

| Size | Fit Range |
|------|------------------|
| S | 20-28cm (8-11") |
| M | 28-36cm (11-14") |
| L | 36-41cm (14-16") |

Webbing width for all belts: S= 2.5cm (1"), M= 4cm (1-1/2"), L= 5cm (2"). For padded belts, numeric portion of belt size equals padded length in centimeters; e.g., M46 has 4cm (1-1/2") wide webbing with 46cm padded length.

Additional Instructions for the Evoflex®

Determine total length needed for mounting:

1. At the selected belt angle, measure from the mounting point on one side across the user's body to the mounting point on the other side.
2. In the Evoflex sizing table, refer to Column D to find the maximum mounting length for the selected size belt.
3. If belt will not be long enough to reach the mounting points, Evoflex Belt Extenders can be used to add up to 12.5 cm (5") per side. See the Evoflex + Belt Extender table below for maximum combined length. Both the Evoflex Belt and Belt Extender can be cut to length if needed. See p. 10 for Belt Extender details.

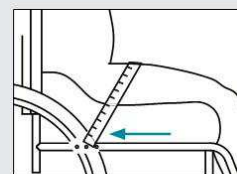

Evoflex®

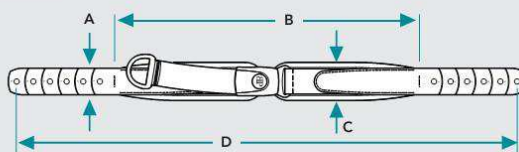

| Size* | A | B | C | D |
|-------|--------------|----------------|----------------|----------------|
| S38 | 2.5cm (1") | 38cm (15") | 5cm (2") | 63cm (24-3/4") |
| M46 | 4cm (1-1/2") | 46cm (18") | 5.5cm (2-1/4") | 76cm (29-3/4") |
| L62 | 5cm (2") | 62cm (24-1/2") | 7cm (2-3/4") | 96cm (37-3/4") |

Evoflex® + Belt Extender*

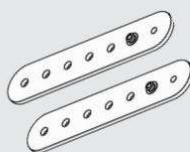

| Belt Size | Max mounting length with Belt Extender |
|-----------|--|
| S38 | 88cm (34-3/4") |
| M46 | 101cm (39-3/4") |
| L62 | 121cm (47-3/4") |

* See page 10 for more about the new Evoflex Belt Extender.

Non-Padded Hip Belts

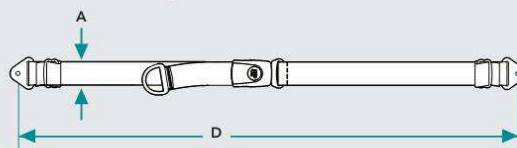

| Size* | A | D |
|-------|--------------|-------------|
| S | 2.5cm (1") | 117cm (46") |
| M | 4cm (1-1/2") | 142cm (56") |
| L | 5cm (2") | 155cm (61") |
| L-EXT | 5cm (2") | 206cm (81") |

Stayflex™, PivotFit™ and Trimline

Measure the maximum width across the shoulders, at the deltoid muscles.

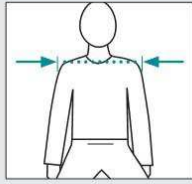

| Size | Shoulder Width |
|------|------------------------|
| XXS* | 21–24cm (8-1/4–9-1/2") |
| XS | 24–28cm (9-1/2 – 11") |
| S | 28–33cm (11–13") |
| M | 33–41cm (13–16") |
| L | 41–48cm (16–19") |
| XL | 48–56cm (19–22") |

*PivotFit Harness only

Monoflex™ Chest Supports

Measure the trunk around the front and sides at the height at which the Monoflex™ will be worn.

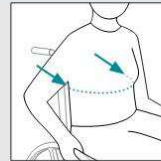

| Size | Pad Length | Pad Width | |
|------|------------------|----------------------------|--------------------------|
| | | Underarm Release (1-piece) | Center Release (2-piece) |
| XS | 31cm (12-1/4") | 7cm (2-3/4") | 5.5cm (2-1/4") |
| S | 39.5cm (15-1/2") | 7.5cm (3") | 6.5cm (2-1/2") |
| M | 46.5cm (18-1/4") | 10cm (4") | 8cm (3-1/4") |
| L | 54.5cm (21-1/2") | 11.5cm (4-1/2") | 9cm (3-1/2") |
| XL | 62cm (24-1/2") | 12.5cm (5") | 9.5cm (3-3/4") |

Calf Supports (Calf Strap and Calf Panel)

Measure the curved distance around the legs from the outside of the wheelchair. Choose a size with enough length for the pad to flex and wrap behind calves.

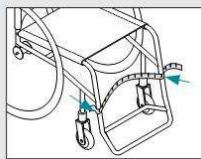

| | |
|---|--------------------|
| S | 35 - 40cm (14-16") |
| M | 40 - 50cm (16-20") |
| L | 50 - 61cm (20-24") |

Ankle Huggers®

Measure circumference above ankle.

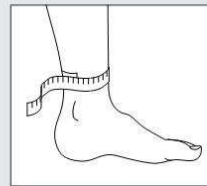

| | |
|----|------------------------------|
| XS | 14 - 17cm (5-1/2 - 6-3/4") |
| S | 16.5 - 20cm (6-1/2 - 8") |
| M | 19 - 25.5cm (7-1/2 - 9-1/4") |
| L | 23 - 28cm (9 - 11") |
| XL | 26.5 - 33cm (10-1/2 - 13") |

Additional sizing information can be found in the product listings throughout this Product Guide and on www.bodypoint.com.

Terms and conditions

LIMITED LIFETIME WARRANTY

Most products manufactured by Bodypoint carry a limited lifetime warranty against defects in workmanship and materials arising under normal use by the original consumer. Product specifications are subject to change. For current specifications and warranty details, contact your local Independent Distributor or contact Customer Service at sales@bodypoint.com or 1-800-547-5716.

LIMITATIONS ON WARRANTIES

The warranties described herein do not extend to normal wear and tear; to products that have been subject to misuse, accident or tampering; nor to products that have been modified in any way other than that specifically described in the product instructions. Normal wear and tear is damage that naturally and inevitably occurs as a result of typical use. Purchaser's sole remedy for defective products shall be repair, replacement or account adjustment at the discretion of Bodypoint. In all circumstances Bodypoint reserves the right to substitute an equivalent product or refund the purchase price of the original product.

THE FOREGOING WARRANTIES ARE IN LIEU OF ALL OTHER WARRANTIES EXPRESSED OR IMPLIED, INCLUDING WITHOUT LIMITATION, IMPLIED WARRANTIES OF MERCHANTABILITY AND FITNESS FOR A PARTICULAR PURPOSE. IN NO EVENT SHALL BODYPOINT BE LIABLE FOR ANY SPECIAL, INDIRECT, INCIDENTAL OR CONSEQUENTIAL LOSSES OR DAMAGES RESULTING FROM THE USE OF THE PRODUCT, INCLUDING WITHOUT LIMITATION, LOSS OF ANTICIPATED PROFITS, EVEN IF BODYPOINT SHALL HAVE BEEN ADVISED OF THE POSSIBILITY OF SUCH POTENTIAL LOSS OR DAMAGE. BODYPOINT SHALL NOT BE LIABLE FOR ANY LOSS OR DAMAGE CAUSED BY DELAY IN FURNISHING PRODUCT.

Bodypoint does not authorize any distributor, dealer, agent, sales person or any third party to change the terms or coverage of this warranty, and any such change shall be null and void. This warranty is non-transferable. This warranty will be governed in accordance with the laws of the State of Washington. The customer consents that jurisdiction under Venue for any action shall be in King County Washington. This warranty information is reprinted here for information purposes only and is subject to change without notice.

TERMS

Standard terms are net 30 days on accounts approved for credit. Any returned check will incur a \$50 service charge. We also accept Visa, MasterCard, or American Express. All shipments are FOB Seattle, Washington.

Product specifications, prices, terms and conditions are subject to change without notice. Contact Customer Service at sales@bodypoint.com or 1-800-547-5716 for further details.

PAST DUE ACCOUNTS

Past due invoices will incur finance charges at the rate of 1.5% per month. Bodypoint reserves the right to hold shipments or require prepayment for any delinquent account.

RETURNS

All returns must be pre-authorized by Bodypoint. Customer must contact Bodypoint within 30 days of the purchase date for a return authorization. All returns are subject to a 15% restocking fee, plus applicable freight charges.

TRADEMARK INFORMATION

- Bodypoint and the Bodypoint Logo are registered trademarks of Bodypoint, Inc. in Canada, China, the EU, India and the USA.
- Strengthen Your Position is a registered trademark of Bodypoint, Inc. in the EU and USA.
- Ankle Huggers is a registered trademark of Bodypoint, Inc. in Canada, the EU and the USA.
- Aeromesh is a registered trademark of Bodypoint, Inc. in the EU and the USA.
- Evoflex is a registered trademark of Bodypoint, Inc. in the USA.
- Cinch-Mount, Flat-Mount, FrameSaver, Stayflex, Laminar Pad, Monoflex, Rehab Latch, PivotFit, MD Series, and MD Pull Straps are all trademarks of Bodypoint, Inc.